

42U CABINETS

- Part Numbers
 PX3SSSAC42L
 PX3SSSTW42L
 PX3SSSFM42L
 PX3SSSAC42R
 PX3SSSTW42R
 PX3SSSFM42R

- Door, Open-Left, Clear Insert
 Door, Open-Left, Twinwall Polycarbonate Insert
 Door, Open-Left, CPVC FM4910 Insert
 Door, Open-Right, Clear Insert
 Door, Open-Right, Twinwall Polycarbonate Insert
 Door, Open-Right, CPVC FM4910 Insert

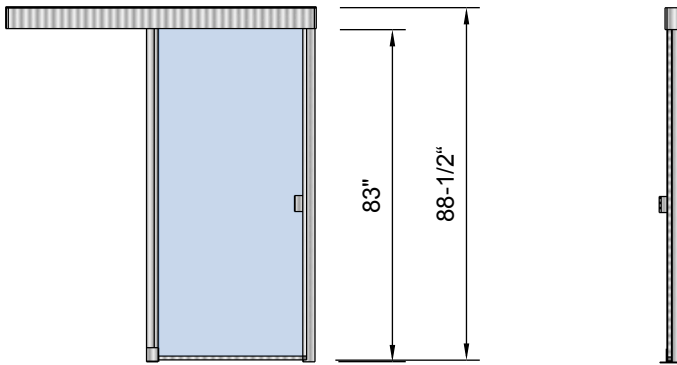

45U CABINETS

- Part Numbers
 PX3SSSAC45L
 PX3SSSTW45L
 PX3SSSFM45L
 PX3SSSAC45R
 PX3SSSTW45R
 PX3SSSFM45R

- Door, Open-Left, Clear Insert
 Door, Open-Left, Twinwall Polycarbonate Insert
 Door, Open-Left, CPVC FM4910 Insert
 Door, Open-Right, Clear Insert
 Door, Open-Right, Twinwall Polycarbonate Insert
 Door, Open-Right, CPVC FM4910 Insert

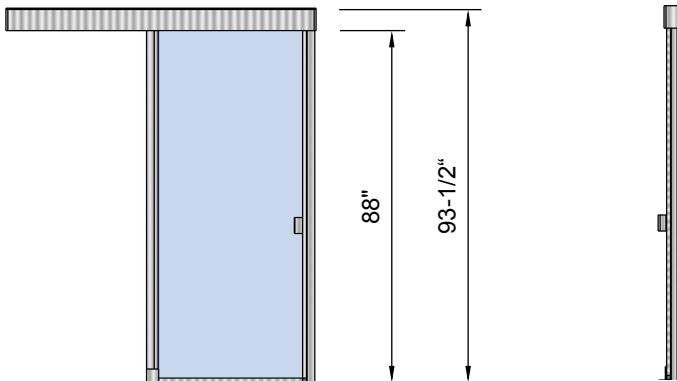

48U CABINETS

- Part Numbers
 PX3SSSAC48L
 PX3SSSTW48L
 PX3SSSFM48L
 PX3SSSAC48R
 PX3SSSTW48R
 PX3SSSFM48R

- Door, Open-Left, Clear Insert
 Door, Open-Left, Twinwall Polycarbonate Insert
 Door, Open-Left, CPVC FM4910 Insert
 Door, Open-Right, Clear Insert
 Door, Open-Right, Twinwall Polycarbonate Insert
 Door, Open-Right, CPVC FM4910 Insert

PX Single Sliding Doors include:

- Auto Close
 Hold Open
 36" Inside Opening
 Packaging Dimensions: 93" x 41" x 8-1/4"
 Weight: 85-95lbs



PRODUCT NAME
**PX Single Sliding Door
 Technical Drawing V5**

PUBLISHED
 November 2, 2016
 MODIFIED
 November 2, 2016

POLARGY, INC.
 256 Gibraltar Drive
 Sunnyvale, CA 94089

PX



POLARGY

**PX Dual Sliding Door
Technical Drawing V6**

PRODUCT NAME

PUBLISHED
November 2, 2016

MODIFIED
November 2,

POLARGY, INC.
256 Gibraltar Drive
Sunnyvale, CA 94089

PX

01

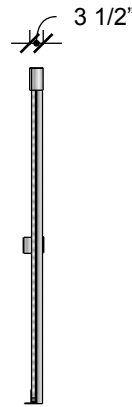
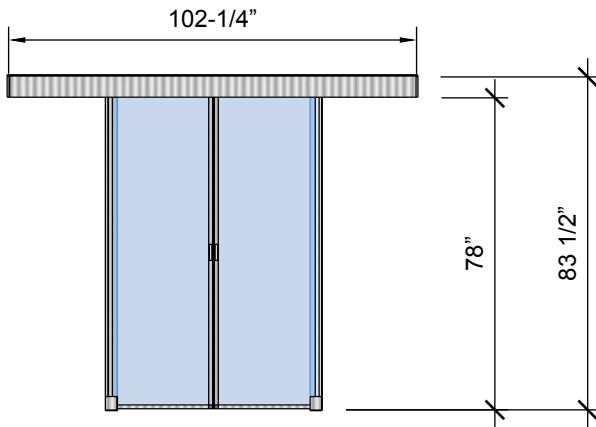

42U CABINETS

Part Numbers
PX3SDSAC42
PX3SDSTW42
PX3SDSFM42

Clear Insert
Twinwall Polycarbonate Insert
CPVC FM4910 Insert

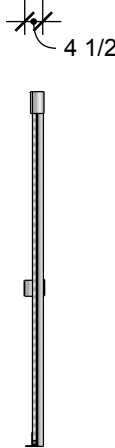
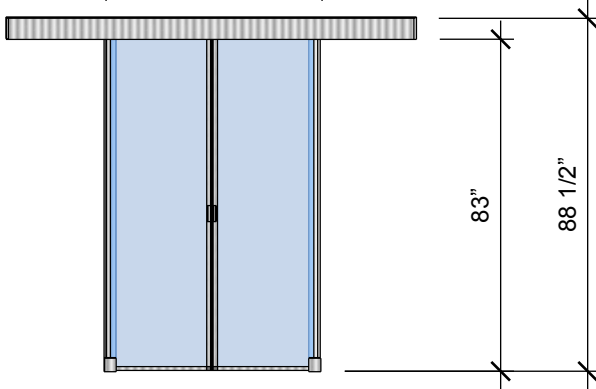
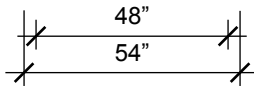

45U CABINETS

Part Numbers
PX3SDSAC45
PX3SDSTW45
PX3SDSFM45

Clear Insert
Twinwall Polycarbonate Insert
CPVC FM4910 Insert

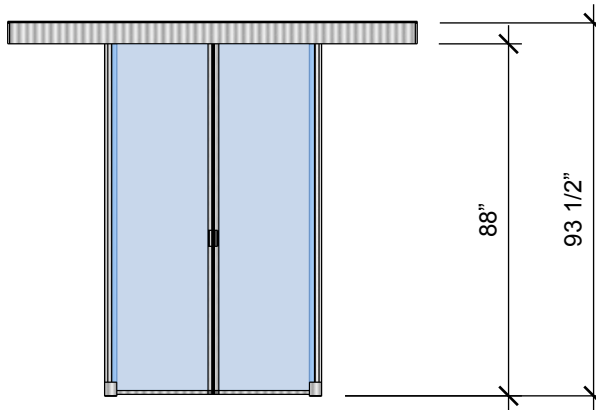

48U CABINETS

Part Numbers
PX3SDSAC48
PX3SDSTW48
PX3SDSFM48

Clear Insert
Twinwall Polycarbonate Insert
CPVC FM4910 Insert

PX Dual Sliding Doors include:

- Auto Close
- Hold Open
- 48" Inside Opening
- Packaging Dimensions: 104-1/4" x 38-3/4" x 6-1/4"
- Weight: 95lbs-105lbs